



Ethanol Maintenance 201

Learn advanced hands-on techniques
for increased productivity

July 25-26, 2019 • December 5-6, 2019

BioFuels
AUTOMATION
University



Take Control of the Loop!

Day One: 8:00 AM - 4:30 PM Day Two: 8:00 AM - 3:00 PM

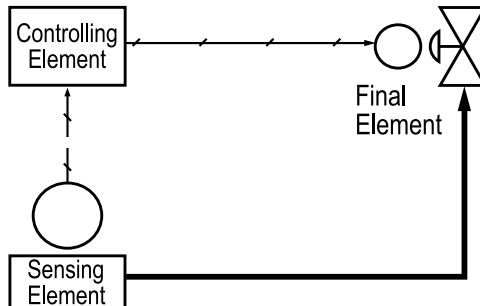

This class will take you through an analysis of the complete control loop, providing you with a deeper understanding of the relationship between the three segments of a control loop. Sensing Element, PID Controller, Final Control Element. C (control) DCS, I and V

Topics Covered:

Loop Configurations

- Hart Modem Software
- Calibration and Validation
- Configuration Tools
- Instrument Configuration Management

Instruments: Sensing Elements

- Detailed Instrument Configuration Labs
 - Flow
 - Level
 - Pressure

Controller PID Tuning: Theory and Practical Application

Valves: Final Control Element

- Valve Sizing Lab
- Valve Actuation
- Smart Valve Positioner Configuration
- Root Cause Failure Analysis

Fee:

\$2,250 per participant.
Fee includes lodging and meals.
Payment information required to
complete registration.

Location:

BioFuels Automation University
Training Center
151 Cheshire Lane North
Plymouth, Minnesota

Space Limited to 10 participants for maximum comprehension
Class lead by highly experienced service professionals,
80% hands-on practical application.



Space is Limited **Register Today!**

Contact Tamma Whealy at 888.870.FUEL(3835) or tamma.whealy@swansonflo.com



151 Cheshire Ln. N, Suite #800, Plymouth, MN 55441
888-870-FUEL(3835) | www.BioFuelsAutomation.com